

OR600
OR2000
USER MANUAL

NITROX

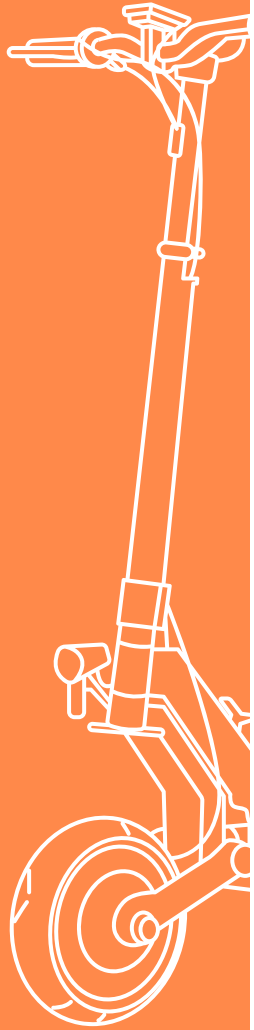

USER MANUAL

01-24

CONTENTS

1. The Main Parts & Technical Specifications
 - 1.1 The Main Parts OR600/OR2000
 - 1.2 Technical Specifications OR600/OR2000
2. Important Safety Instructions
3. Operational Instructions
 - 3.1 First Assembling
 - 3.2 Folding/Unfolding
 - 3.3 Display
 - 3.4 Riding Operations Instructions
 - 3.4.1 Before Riding
 - 3.4.2 Riding
 - 3.4.3 Braking
4. Maintenance
 - 4.1 Tyres
 - 4.2 Battery
 - 4.3 Charger
 - 4.4 General Recommendations
5. Warranty Policy
 - 5.1 Warranty Scope
 - 5.2 Warranty Limitations
 - 5.3 Warranty Application Process
6. Contact Us

1.1 The Main Parts OR600/OR2000

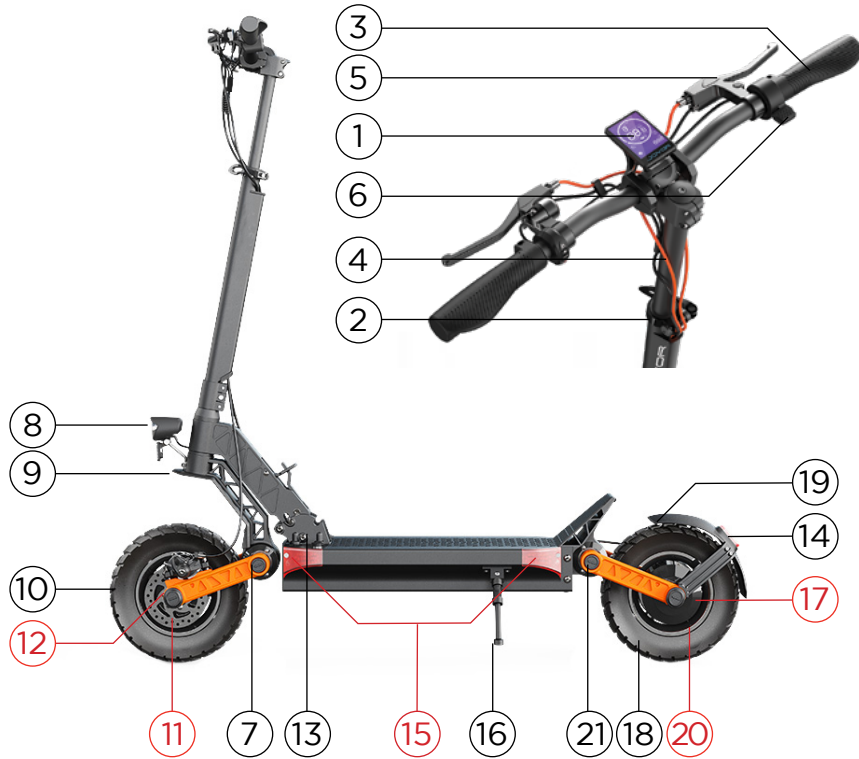

1. LCD display
2. Lever lock for handlebar height adjustment
3. Handlebar sleeve
4. Brake wire
5. Brake handle
6. Throttle
7. Front suspension
8. Front light
9. Front mudguard
10. Front air tyre
11. Front disc brake (hydraulic on OR2000)
12. Front motor (OR2000)
13. Folding system
14. Rear light
15. Side lights
16. Parking stand
17. Rear motor
18. Rear air tyre
19. Rear mudguard
20. Rear disc brake (hydraulic on OR2000)
21. Rear suspension

There might be slight differences between the product and the pictures. In order to protect your safety and the safety of others, please read the instructions before use. Please use this product in accordance with the laws and regulations of your local area. Joyor is not responsible for any claims, liabilities or losses that arise or may arise due to consumers' violation of local laws and/or regulations.

1.2 Technical Specifications OR600/OR2000

Model	OR600	OR2000
Max Load	120Kg	
Max Speed	20Km/h limited	
Gradeability	20°	
Max Range	40-55Km	70-85Km
Frame	Aluminum alloy	
Tyre size	10 in.	
Tyre type	Air tyre	
Brake	Front & rear disk brakes	Front & rear hydraulic brakes
Net weight	22.1kg	27.1kg
Size unfolded	1245*610*1230mm	
Size folded	1150*610*525mm	
Voltage	48V	60V
Battery capacity	13 Ah	18 Ah
Motors	1	2
Power	600W	2X 1000W
Charger input voltage	AC110-240 V	
Charger input current	2A	
Suspension	Double front & double rear suspension with swingarm	
Display	Multicolor LCD display	
Lights	Front, rear and side	
Charging hours	6,5-7 h	10-12 h

Vibrations:

- The vibration value exposed to the hand-arm system is 2.5 m/s².
- Measurement uncertainty 0.5 m/s². The vibration can be altered due to the rough terrain where the scooter is circulated. However, this alteration will not depend on the scooter.

Airborne noise:

- The A-weighted emission sound pressure level is 35 db (A)

Command systems:

The electric scooter does not have the possibility of remote control. It is not necessary to use any additional means to prevent unauthorized use for safety measures because this machine is not considered a dangerous industrial machine but a vehicle for individual transport for public use.

From the driver's position, the driver can operate all the drive components necessary for the operation of the machine: brake, display with accelerator, handlebar, light switch, bell.

The displacement of the electric scooter with driver on board can only be implemented if the driver is at his command post, is prepared and only if the speed of the electric scooter is greater than 0 km/h, being started mechanically by pushing the scooter forward and applying the electric throttle only afterwards.

2 IMPORTANT SAFETY INSTRUCTIONS

- Nitrox electric scooter is a personal transportation vehicle and is designed for one person only. Please do not transport a passenger on this electric scooter.
- Nitrox electric scooter is designed for adults only. **People under the age of 16 cannot use this vehicle.** Children should not use the vehicle or play with it.
- This appliance can be used by children aged from 16 years and above and persons with reduced physical, sensory or mental capabilities or lack of experience and knowledge if they have been given supervision or instruction concerning use of the appliance in a safe way and understand the hazards involved.
- Cleaning and user maintenance shall not be made by children without supervision.
- Please wear a safety helmet when riding the electric scooter.
- The vehicle cannot be used in unauthorized spaces and the user has to comply with the current local norms and regulations of the circulation of the personal mobility vehicles
- Do not ride the electric scooter on the unsafe surface.
- Please practice on an open traffic-free space on gear level 1 before riding on the bicycle lane.
- Please during the riding operations always keep both hands on the handlebar and both feet on the standing board. Please do not jump on the standing board.
- Do not turn off the motor power while riding the scooter.
- If you encounter someone or obstacles in front of you during the riding, please release the throttle first, and brake the left brake handle (rear brake) first and then the right brake handle (front brake) next to deceleration or stop braking.

- Do not try to ride over a gap of more than 3 cm. This may cause injury to the rider or damage the vehicle.
- When riding on the rough or bumpy road, please slow down the electric scooter or stop riding the vehicle.
- A user must adjust the height of the handlebar tube according to their height to ensure a safe, stable and comfortable ride.
- Do not ride Nitrox electric scooter on slippery surfaces such as oil or ice.
- Do not use Nitrox electric scooter in the weather conditions with the temperature below -5.
- Do not leave the product immersed in a water depth of more than 3 cm to avoid damage to the electrical parts of the vehicle. Do not store the vehicle in a place with high humidity levels.
- Avoid riding the Nitrox electric scooter in adverse weather conditions like rain, snow or wind storm to prevent an accident. If riding in these conditions, never exceed the speed of 10 km/h.
- If the electric scooter is not used for a period of longer than 30 days, regularly charge it at least every 30 days. The charging port must be kept clean and dry at all times.
- When unfolding the vehicle, please press the folding system handle till it clicks and make sure that it is in place.
- When charging, always ensure that somebody is supervising the charging site. If the charger temperature increases too much, stop the charging process.
- Always only use the original charger that corresponds to your scooter's model.
- Please keep all plastic bags of the packaging of the product away from children to avoid suffocation.

Instructions regarding installation and assembly, aimed at reducing noise and vibrations:

Before using the equipment, tighten all the fastening screws of the screen with the accelerator and the brake lever, making sure that these components are fixed and do not move, to avoid vibrations.

To prevent the handlebar vibrations and shaking adjust and, if necessary, loosen the screws inside the handlebar sleeves when folded.

Before using the equipment, make sure that there are no loose cables on the rear wheel and motor part, to avoid high noise from the motor.

Every 2 months it is recommended to check and tighten the nuts on the rear wheel of the motor, to avoid vibrations and high noise from the motor.

3 OPERATIONAL INSTRUCTIONS

3.1 First assembling

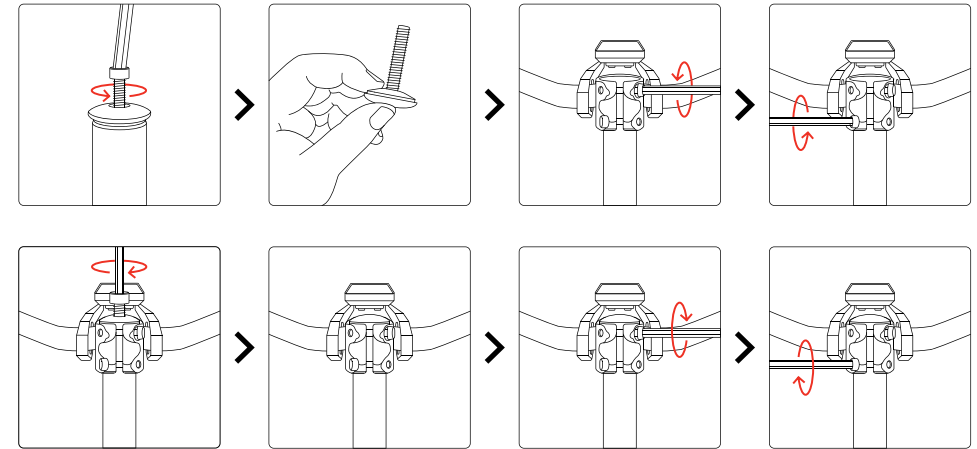

3.2 Folding/Unfolding

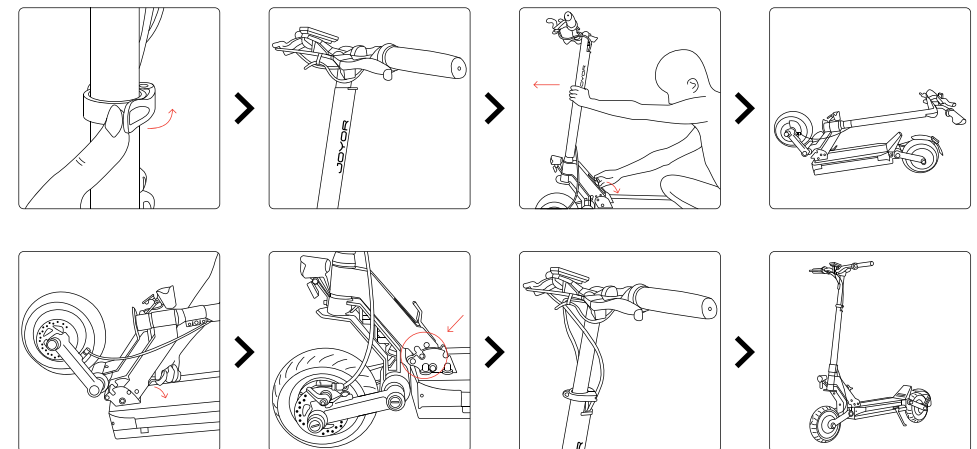

3.3 Display

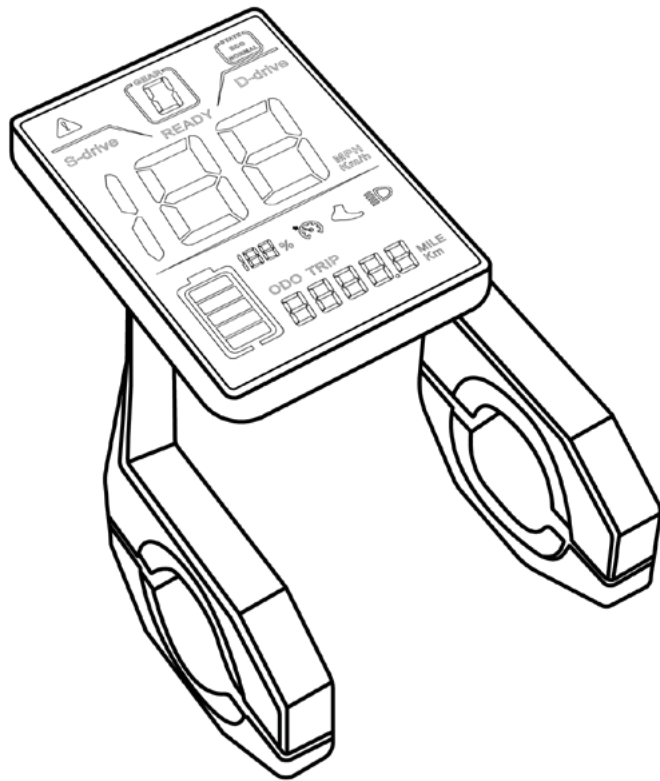

Home Screen

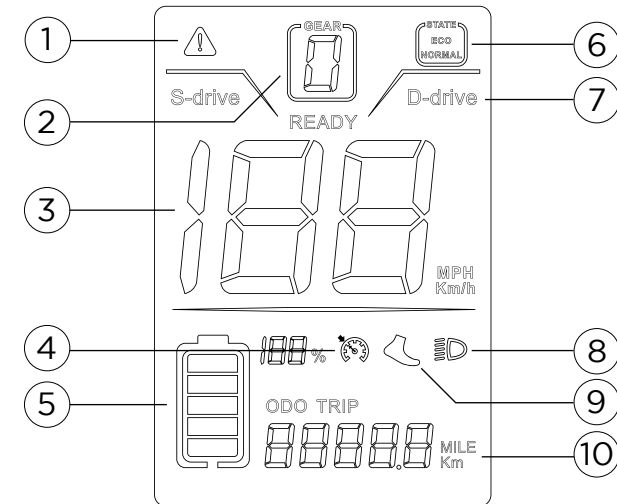

1. Error code display
2. Power gear display
3. Speed Display
4. Cruise
5. Battery display
6. Starting mode
7. Single/dual drive riding
8. Lighting
9. 6km/h boost mode
10. Multifunctional display

Home screen description

Battery display:

From bottom to top, the battery level increases sequentially, the lowermost display grid represents low battery, and the uppermost display grid represents high battery. The left side displays the corresponding remaining battery percentage.

Multifunctional display area:

Display total mileage, single mileage, real-time voltage display, running time prompt, fault prompt and switch handle voltage value.

Single/dual drive riding:

Mode selection, the default mode is single drive. S-drive is one motor drive and D-drive is two motors drive

Starting mode of the scooter:

ECO is non-zero startup mode and NORMAL is Zero startup mode.

Button panel





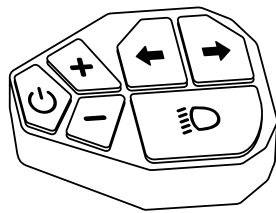



Joyor S5/S10-S







Joyor S-PRO

Introduction to key functions



Button	Operation	Function
	Press and hold for 3 seconds	1. Turn on/off dual drive mode. (Only works for electric scooters with two motors.)
	Short press	1. In the main interface, increase the gear.
	Press and hold for 3 seconds	1. In the main interface, start the push function (need to be in 1-3 gears, cancel when braking).
	Short press	1. In the main interface, reduce the gear.
	Press and hold for 3 seconds	1. Turn on/off the display.
	Short press	1. In the main interface, turn on/off the headlamp. 2. Enter the function menu interface to switch function options.
	Short press	1. Turn the left turn signal on/off.
	Short press	1. Turn the right turn signal on/off.
	Short press	1. Turn on/off the lights.

Function menu settings



Press  and  for 3S to enter the setting interface or return to the main interface. Short press  to switch setting options. After setting, long press  and  to return to the main interface.

Parameter setting and definition



P02: Mileage unit

After entering the setting interface, then press  to switch to P02: press  or  to select 0 (MILE-default) or 1 (KM).



P04: Sleep time

From 0 to 60 minutes, 0 means always on. After entering the setting interface, then press  to switch to P04: press  or  to select from 0 to 60 (Default: 5 minutes).

P06: Wheel diameter

Calculated by inch, the precision is 0,1. After entering the setting interface, then press  to switch to P06: press  or  to select the diameter (Default: 10).

P07: Number of tachometer magnets

Range: 1-100. After entering the setting interface, then press  to switch to P07: press  or  to select the number of the magnets (Default: 30).



P09: Zero start

After entering the setting interface, then press  to



switch to P09: press  or  to 0.

Note: The system default is 1 (non zero startups). After startup, it defaults to gear 0. In order to ride safely, please confirm to start in gear 1. Then press down the acceleration handle while sliding with your feet to start riding.



P12: Strength setting

Range: 0 to 5. After entering the setting interface, then press  to switch to P12: press  or  to select the strength (Default: 5).



P15: Motor drive signal percentage

Range: 1 to 100. After entering the setting interface, then press  to switch to P15: press  or  to select the percentage (Default: 100).

P16: Enable cruise

After entering the setting interface, then press  to switch to P16: press  or  to select 0 (OFF) or 1 (ON). After starting cruise, press the acceleration handle until the cruise icon lights up. At this time, releasing the handle will not stop the assistance. When shifting gears, braking or pressing the acceleration handle again, you will exit cruise.

P99: Restore to initial settings

Enter the menu, short press the  or  key, the value 00099 flashes, and the display returns to the main interface after long-pressing the  key for 5 seconds, the setting is successfully done.

ODO: To clear ODO

In the ODO parameter setting interface, briefly press the  button and then press and hold for 5-6 seconds until the number is zero.

Error Codes

The number corresponding to the multi-function area represents the corresponding fault content. The specific status is as follows:

NO.	Error Code	Definition
1	ERRO 1	Rear motor hall sensor malfunction
2	ERRO 2	Accelerator throttle malfunction
3	ERRO 3	Rear drive controller malfunction
4	ERRO 4	Brake malfunction
5	ERRO 5	Controller under voltage malfunction
6	ERRO 6	Communication malfunction (Display unable to receive controller data)
7	ERRO 7	Communication malfunction (Controller unable to receive display data)
8	ERRO 8	Rear drive stall protection (Rear drive blocking protection)
9	ERRO 9	Temperature protection
11	ERRO 11	Front motor hall sensor malfunction
13	ERRO 13	Front drive controller malfunction
18	ERRO 18	Front drive stall protection (Front drive blocking protection)

3.4 Riding Operations Instructions

3.4.1 Before Riding

- Choose a suitable venue for riding.
- Unfold the electric scooter according to the instructions.
- Adjust the height of the handlebar tube according to your height.

3.4.2 Riding

- Press the power button to turn on the power. The speed is set by default to gear level 1.
- For safety purposes, Joyor electric scooter has a safe start design which means the motor can start only when the speed of the vehicle is above 0. It prevents motor start when the acceleration handle is pressed by mistake. To start the riding operations, put one foot on the standing board and the other foot on the ground and kick scoot it like a classic kick scooter. When the scooter is in motion and its speed is above 0, smoothly use the acceleration handle to start the motor. Once the motor starts, put the other foot on the standing board and continue riding.
- When riding, adjust the gear level from 1 to 3, use lights and horn according to the road conditions and according to the situation.
- Be aware of the cruise control function. Cruise control function is activated when the acceleration handle is pressed with the same pressure for 3 seconds.
- Be aware of the possibility of unpredictable sudden obstacles on your way and control the speed level.

3.4.3 Braking

- Use the rear brakes handle for braking under normal circumstances. Use front brake handle for braking in emergency situations.
- The greater pressure you put, the greater braking force will be applied. Be aware that hard braking may result in an accident due to slipping of the wheels, loss of balance and fall of the vehicle. Hard braking might also cause damage to the tyre.

4 MAINTENANCE

Cleaning and maintenance to be carried out by the user cannot be carried out by children under 16 years of age.

4.1 Tyres

- Nitrox electric scooter uses rubber elastic tyres. When the tyres are worn out or have a puncture, they need to be replaced timely.
- Contact the official distributor to replace the original tyres.
- Inspect your scooter and its tyres every month, check if the screws are tightened enough. If they are loose, tighten them.

4.2 Battery

- Nitrox electric scooter is equipped with a lithium polymer battery. The average lifespan of the battery is 1000 cycles. Under normal use and maintenance, the battery lifespan can generally reach more than 1000 cycles.
- Before using the scooter for the first time, please charge the battery to the full charge.
- Avoid totally depleting your scooter's battery before charging. Always make sure it is minimum 10 % charged. For satisfactory vehicle performance, the battery has to be charged minimum 50 %.
- Do not leave your electric scooter with a significantly discharged battery for a few hours. Charge it promptly.
- When storing the electric scooter for a long period, make sure the battery is at least 40-50 % charged. It is advisable

to charge your scooter minimum once per 30 days.

- Always use only the original Joyor charger that corresponds to the model of the scooter.
- Do not leave your electric scooter in the cold temperature below 0 or under the direct sun. Keep the battery dry. Negative environmental conditions can damage the battery.
- Polymer lithium batteries have to be treated with extreme caution. Unappropriated charging, damage or overheating can result in a fire. Do not leave your electric scooter to charge without supervision. Do not leave the electric scooter to charge overnight. Always supervise the electric scooter while it is charging and avoid battery over-charge. Do not use, charge or leave a damaged battery unattended and follow the disposal protocols immediately.

4.3 Charger

Chargers:

54.6V (OR600), 67.2V (OR2000)

- **54.6V:** Input 100-240V ~, 2.8A (MAX) 50 / 60Hz; Output 54.6V = 2.0A;
- **67.2V:** Input 100-240V ~, 2.8A (MAX) 50 / 60Hz; Output 67.2V = 2.0A;

The dedicated charger provided by Nitrox has a charging protection timing function.

WARNING: For the purposes of recharging the battery, only use the detachable supply unit provided with this appliance

Charging instructions

- Open the charging port cover on the electric scooter and insert the charger output connector into the charging port.
- Insert the charger input power plug into the power socket (AC110V-220V).
- Charger light is red to indicate that charging is in progress; when the charger light turns green, it indicates that the battery is fully charged.
- When charging the battery, place it in a dry, ventilated environment.

4.4 General Recommendations

- Please check and adjust screws monthly. Under conditions of professional or intensive use, it is recommended to change the screws every 6 months.
- Please frequently check and adjust the breaks.

5 WARRANTY POLICY

5.1 Warranty Scope

- This limited warranty covers any defects in the new Joyor devices accompanied by this limited warranty statement for a period of 24 months after the first retail purchase for the **electric parts** (display, controller, motor and charger) against manufacturing defects on a replacement basis, and a 12 months or 2000km warranty for the battery (whichever comes first) **under normal installation, use, service and maintenance.**
- Only consumers purchasing this device from an authorized Joyor retailer or reseller may obtain coverage under this limited warranty.
- This warranty extends to the original purchaser only and is non-transferable.

5.2 Warranty Limitations

This limited warranty does not cover any problem that is caused by:

- Commercial use, accident, abuse, neglect, shock, heat or humidity beyond product specifications, improper installation, operation, maintenance or modification.
- Any misuse contrary to the instructions in the User Manual.
- Malfunctions caused by other equipment.
- This limited warranty is void if a product is returned with removed, damaged or tampered labels of any alterations (including the unauthorized removal of any component or external cover).

- Nitrox does not cover the cost of national/ international warranty shipping at any time.
- This limited warranty is valid with the original receipt of purchase from the authorized dealer.
- Excludes consumable wearing fittings.
- Excludes parts with physical damages, incomplete/ broken cable connections.
- Excludes misuse, modification, negligence and use of the scooter in wet conditions.
- Excludes professional and hire use.

5.3 Warranty Application Process

- Nitrox will not provide any warranty coverage unless your claim is in compliance with all terms of this limited warranty statement and you follow the proper return procedure.
- To request warranty service, you may contact us .

6 CONTACT US

Technical Support

Please contact us.

NITROX

Nordbutiker AB

Gösvägen 28
76141 Norrtälje
08-522 309 80
info@nordbutiker.se